

This article was downloaded by:

On: 26 January 2011

Access details: *Access Details: Free Access*

Publisher *Taylor & Francis*

Informa Ltd Registered in England and Wales Registered Number: 1072954 Registered office: Mortimer House, 37-41 Mortimer Street, London W1T 3JH, UK



## Liquid Crystals

Publication details, including instructions for authors and subscription information:

<http://www.informaworld.com/smpp/title~content=t713926090>

### Optical determination of the pitch-dependent diffusion constant in a cholesteric liquid crystal

R. Stannarius<sup>a</sup>; A. Frieser<sup>a</sup>; K. Hänsel<sup>a</sup>

<sup>a</sup> Sektion Physik der Karl-Marx-Universität, Leipzig, G.D.R.

**To cite this Article** Stannarius, R. , Frieser, A. and Hänsel, K.(1988) 'Optical determination of the pitch-dependent diffusion constant in a cholesteric liquid crystal', *Liquid Crystals*, 3: 8, 1137 – 1146

**To link to this Article:** DOI: 10.1080/02678298808086569

**URL:** <http://dx.doi.org/10.1080/02678298808086569>

PLEASE SCROLL DOWN FOR ARTICLE

Full terms and conditions of use: <http://www.informaworld.com/terms-and-conditions-of-access.pdf>

This article may be used for research, teaching and private study purposes. Any substantial or systematic reproduction, re-distribution, re-selling, loan or sub-licensing, systematic supply or distribution in any form to anyone is expressly forbidden.

The publisher does not give any warranty express or implied or make any representation that the contents will be complete or accurate or up to date. The accuracy of any instructions, formulae and drug doses should be independently verified with primary sources. The publisher shall not be liable for any loss, actions, claims, proceedings, demand or costs or damages whatsoever or howsoever caused arising directly or indirectly in connection with or arising out of the use of this material.

## Optical determination of the pitch-dependent diffusion constant in a cholesteric liquid crystal

by R. STANNARIUS, A. FRIESER and K. HÄNSEL

Sektion Physik der Karl-Marx-Universität, Leipzig, G.D.R.

(Received 2 November 1987; accepted 4 February 1988)

The concentration profile of a cholesteric compound diffusing into a nematic liquid crystal is observed with optical methods. We propose new experimental initial and boundary conditions which allow a more accurate mathematical solution of the differential equation involved. A numerical approach is applied to compute the concentration profiles with a concentration dependent diffusion constant. Diffusion is found to decrease with the shorter pitch length.

### 1. Introduction

Although diffusion in cholesteric liquid crystals has been studied with several methods in recent years, little progress has been achieved in its theoretical understanding. In addition to N.M.R. spectroscopy the optical study of the direct mass transport is an important tool for diffusion measurements in cholesteric liquid crystals. Pioneering work in this field has been done by Hakemi and co-workers (see e.g. [1-4]).

In the presented experiments, a concentration gradient of a cholesteric compound is produced by special preparation of a nematic liquid crystal contained in a sandwich cell. With the particular surface preparation, the distribution of the cholesteric compound can be detected from Grandjean bands with a microscope. The component of the diffusion tensor  $\mathbf{D}$  involved is the average of  $D_{\parallel}$  (parallel to the local director) and  $D_{\perp}$  (perpendicular to the pitch axis and the local director); this will be denoted by  $D$ .

In this paper we show that with specially chosen boundary conditions the computation of the emerging diffusion profile can be facilitated and carried out more accurately. Further we discuss the pitch dependence of the diffusion constant  $D$ .

### 2. Experimental

Figure 1 shows the geometry of the diffusion channel. The nematic liquid crystal is contained between two glass plates. The spacing of these plates was determined from interference maxima with an infrared spectrometer. The right hand end and the long sides of the diffusion channel are closed with spacer foil, the dimensions of the channel being 20 mm and 1 mm. At the start of the experiment, the diffusion channel was filled with the pure nematic. To the left a container is attached to the channel which is filled with the cholesteric mixture at the start of measurement. The resulting concentration gradient leads to a macroscopic flow of the cholesteric compound into the channel. As the volume and height ( $c.$  0.5 mm) of the container are much greater than the volume and thickness  $d$  of the diffusion channel (about  $10 \mu\text{m}$ ), the concentration of cholesteric liquid crystal in the source can be taken to be constant.

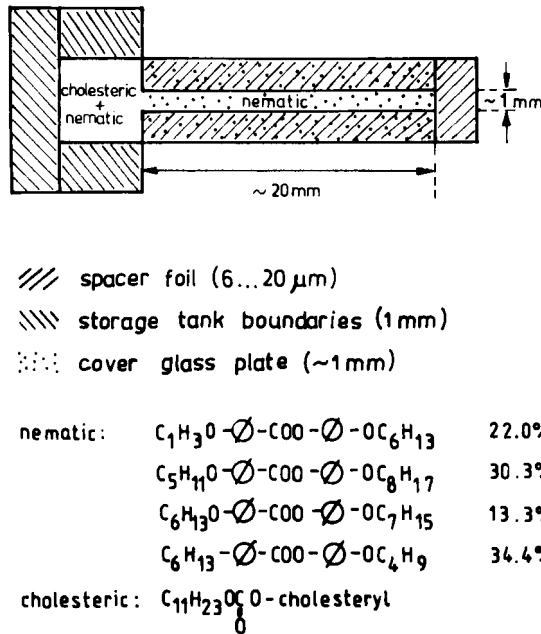

Figure 1. Geometry of the diffusion cell, seen from above.

An exact calculation of the flow

$$\mathbf{j} = -D \text{grad } c$$

shows that the amount of cholesteric mixture diffusing into the channel during the time of experiment is much less than 1 per cent of the total amount of cholesteric mixture in the tank.

The bulk orientation of the liquid crystal is determined by the alignment at the surface. Uniform alignment is obtained by using various substrata that have an aligning effect on these molecules. It is well-known that the director of a nematic sandwiched between two substratums rubbed with paper or cloth aligns parallel to the rubbing direction. However, the most reliable process for parallel homogeneous alignment is oblique incidence evaporation of SiO. [5–9]. A comprehensive survey of this and other methods is given, by Cognard [9]. For the topography of oblique evaporated silicon oxide and its effect to the director orientation see [5, 6].

The determination of the concentration profile by Grandjean bands requires a homogeneous planar alignment. Alternatively, the local concentrations of cholesteric could be observed from the fingerprint textures of homeotropic orientation. In the diffusion cells used for our experiments we have established a planar orientation at the surface.

A small number of cells were made with the rubbing technique, whereas most cells were prepared with obliquely (about 60°) SiO evaporation onto glass substrates, after suitable cleaning.

Because of the preparation of the glass plates, a uniform orientation of the pitch axes forms during the diffusion process in the channel. The pitch axes are directed perpendicular to the diffusion flow and so normal to the glass planes. For such an orientation, the concentration profile leads to the formation of the observed Grandjean bands [1–4] which are detected with a microscope. From the position of

these bands we can draw conclusions about the concentration at discrete distances from the source. In a given cell, we observe only a few disclination lines (about 6..10) at locations where

$$p_0 = d(2n + 1)/(n^2 + n),$$

where  $n = 1, 2, \dots$  (the average of two adjacent regions where  $d$  is an integer multiple of  $p_0/2$ ). To obtain more data for the evaluation of the concentration profile, the positions were recorded at different times and then scaled according to equation [5] (cf. the next section). Further data were found from two other diffusion cells with exactly the same conditions except for a different channel thickness. In these cells, the bands appear for different  $p_0$  values and hence indicate different concentrations (see figure 4).

The sample investigated was a mixture of three alkyloxyphenyl-alkyloxybenzoates of different chain length and 34.4 per cent of butyloxyphenyl-hexylbenzoate. This material is nematic at room temperature with  $T_{NI}$  equal to 70.5°C. The cholesteric compound, the diffusion of which is actually measured is cholesteryl-undecylcarbonate (ChUC). All measurements were performed at 25°C. The sample temperature was controlled to better than 0.5 K by a thermostat.

### 3. Theory

The diffusion equation which governs the distribution of concentration  $c(x, t)$  of the cholesteric compound can be considered to be one dimensional. The coordinate  $x$  is taken in the direction parallel to the channel,  $x = 0$  at the left hand end of the channel (stock container), the length of the channel is  $L$ . The initial condition is

$$c(x, 0) = \begin{cases} 0 & \text{for } 0 < x < L \\ c_0 & \text{for } x \leq 0 \end{cases}, \quad (1)$$

and the boundary conditions are

$$\begin{aligned} c(0, t) &= c_0 \quad (\text{constant}), \\ \partial c / \partial x(L, t) &= 0 \quad (\text{isolated}). \end{aligned}$$

To calculate the evolution of  $c(x, t)$ , we use Fick's second law

$$\frac{\partial c}{\partial t} = \frac{\partial}{\partial x} D \frac{\partial c}{\partial x}. \quad (2)$$

With a constant diffusion coefficient, the solution of

$$\frac{\partial c}{\partial t} = D \frac{\partial^2 c}{\partial x^2} \quad (3a)$$

can be obtained analytically. The solution can be expressed as a power series [10]

$$c(x, t) = c_0 - \sum_{n=0}^{\infty} a_n \sin((n + 1/2)\pi x/L) \exp(-D(n + 1/2)^2 \pi^2 t/L^2),$$

with

$$a_n = 2c_0/(\pi(n + 1/2))$$

for the given initial conditions. The sum is easily computed as the terms with large  $n$  vanish rapidly with increasing  $t$  (only long range concentration fluctuations with low

$(n + 1/2)\pi/L$  are important). As during the timescale of our experiments the concentration of chiral material at the right hand side of the channel stays negligibly small, the diffusion is not sensitive to the right boundary, and the previous equation is equivalent to the solution for a semi-infinite channel,

$$c(x, t) = c_0 \operatorname{erfc}(x/(4Dt)^{1/2}), \quad (4)$$

where  $\operatorname{erfc}$  is related to the gaussian error function by

$$\operatorname{erfc}(x) = 1 - 2/\pi \int_0^x \exp(-y^2) dy.$$

In the cholesteric system investigated, we expect a dependence of  $D$  on the concentration of the cholesteric via different pitch values. Yaniv *et al.* [11] as well as Luzar *et al.* [12] found a dependence of  $D_h$  (in the helix direction) approximately of the form  $p_0^{-2}$  by N.M.R. measurements. In the present investigations, the diffusion is observed perpendicular to the pitch, we measure an average of  $D_{\parallel}$  and  $D_{\perp}$ , and a different dependence on pitch length can be expected. An analytical solution of the diffusion equation with concentration dependent diffusion coefficient is in general impossible. We have therefore solved the time development of  $c(x)$  by a numerical method, solving Fick's first law for discrete spatial intervals  $x_n$  and successive discrete time steps  $t_i$ . The time intervals  $\Delta t$  were chosen such that the change of concentration at one computation step

$$\begin{aligned} \Delta c &= c(x_n, t_{i+1}) - c(x_n, t_i) \\ &= (c(x_{n+1}, t_i) + c(x_{n-1}, t_i) - 2c(x_n, t_i))D\Delta t/\Delta x^2, \end{aligned}$$

is small compared to  $c(x_n, t_i)$ , i.e.  $D\Delta t/\Delta x^2 \ll 1$ .

Under the special conditions of our experiment, the diffusion equation

$$\frac{\partial c}{\partial t} = D \frac{\partial^2 c}{\partial x^2} + \frac{dD}{dc} \left( \frac{\partial c}{\partial x} \right)^2 \quad (3b)$$

as well as the initial condition [1] are invariant to the substitution  $x' = nx$ ,  $t' = n^2t$ . Therefore the time evolution of the concentration gradient is described by

$$c(nx, n^2t) = c(x, t) \quad (5)$$

as long as the diffusion has not reached the right hand boundary of the diffusion cell ( $L^2 \gg 4Dt$ ) which holds for the total time of our measurements. Once we have found the concentration profile  $c(x)$  which is a solution to equation (4) for an arbitrary moment  $t_0 > 0$ , we can compute its time dependence according to equation (5).

#### 4. Computational results

The special form of the relation between  $D$  and  $c$  is not known *a priori*. In principle, the numerical method described can process arbitrary functions of  $D(c)$ . Any realistic function  $D(c)$  can be expanded in a power series of  $c^n$ . In order to keep the number of undetermined parameters small, we have assumed a dependence

$$D = D_0(1 + D_1c). \quad (6)$$

This simplified relation does not reflect the complicated general dependence of  $D(c)$ . However, the measured data in the observed region of low concentration of

the cholesteric can be fitted very well. The fitting parameter  $D_0$  gives a reliable value of an absolute diffusion velocity and  $D_1$  stands for the *average* slope of the  $D(c)$  curve in the observed region. Computations with other functions, where higher terms of  $c$  were included, show that terms higher than linear can hardly be extracted from the experimental diffusion profile in the region of low concentrations investigated, even if more sampling points are available.

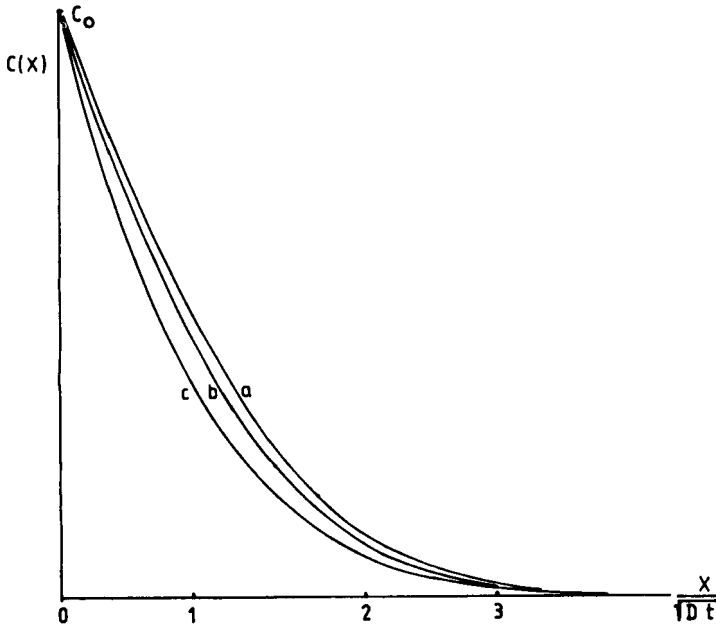
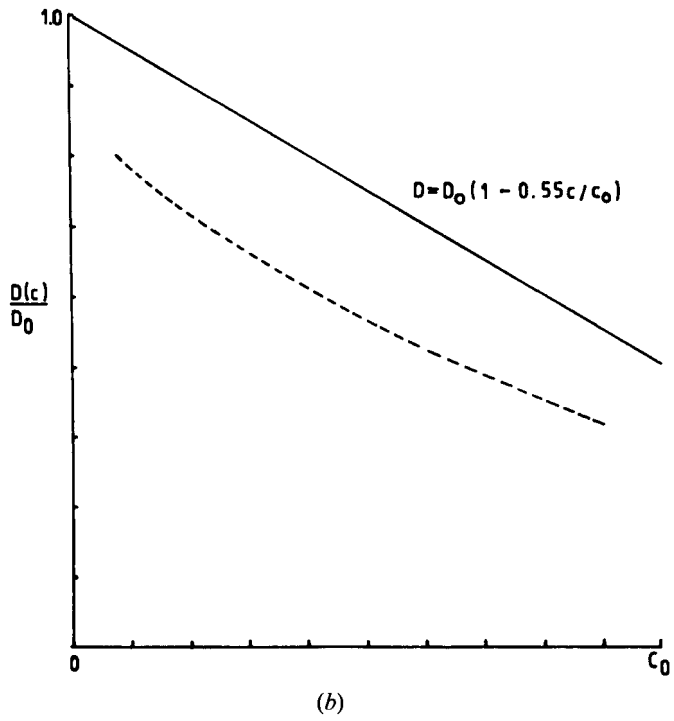
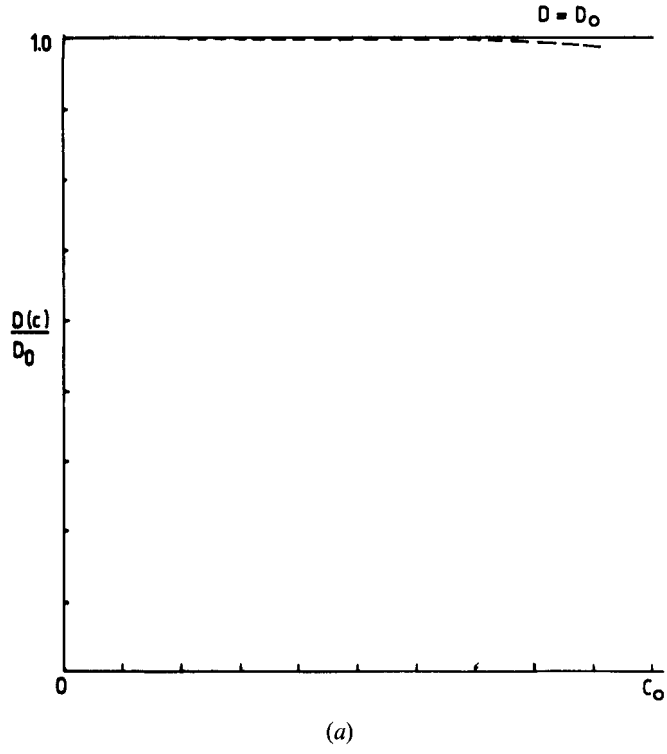

Figure 2. Concentration profiles, solutions of the diffusion equation, computed from equations (2) and (5) with different values of  $D_1$ . (a)  $D_1 c_0 = 0.00$ , (b)  $D_1 c_0 = -0.20$ , (c)  $D_1 c_0 = -0.55$ .

Figure 2 shows several concentration profiles for different  $D_1$ . We note that, as we have discussed the absolute values of  $x$  and  $t$  as well as  $c$  can be adapted to the experimental curve by scaling  $c_0$  and  $D_0$ , only the shape of  $c(x)$  and the value of  $D_1$  (determining the ratio of diffusion coefficient in the pure nematic and at  $c_0$ ) are important. The initial concentration  $c_0$  is known in the experiment, the  $D_0$  and  $D_1$  values were found by fitting the computed curves to the experiment results. For each value of  $D_1$  (running in steps of  $0.05/c_0$  from 0 to  $0.9/c_0$ ), the best value of  $D_0$  was computed by a least square fitting procedure (by scaling  $x$ ). The sum of the squared deviations was recorded. For each value of  $D_1$ , we find a minimum deviation and the corresponding best adapted scaling factor  $x$ . The best adapted parameter  $D_1$  is that belonging to the minimum standard deviation. Figure 5 gives a plot of the calculated deviations in arbitrary units.

Another procedure has been proposed in previous papers by Hakemi [2]. He substituted the values of  $x_n$ ,  $c_0$  and  $t$  of the  $n$ th grandjean band (belonging to a known concentration  $c_n$ ) in the solution of the diffusion equation for constant  $D$ , thus determining different  $D_n$  for every concentration. We have proved that this approach leads to erroneous results, as is seen from figure 3, where we compare the initial  $D(c)$  dependencies (cf. equation (6)), upon which the computations were based, to  $D(c)$  values calculated with this method from the computed  $c(x)$  profiles. The solid lines



Downloaded At: 16:03 26 January 2011

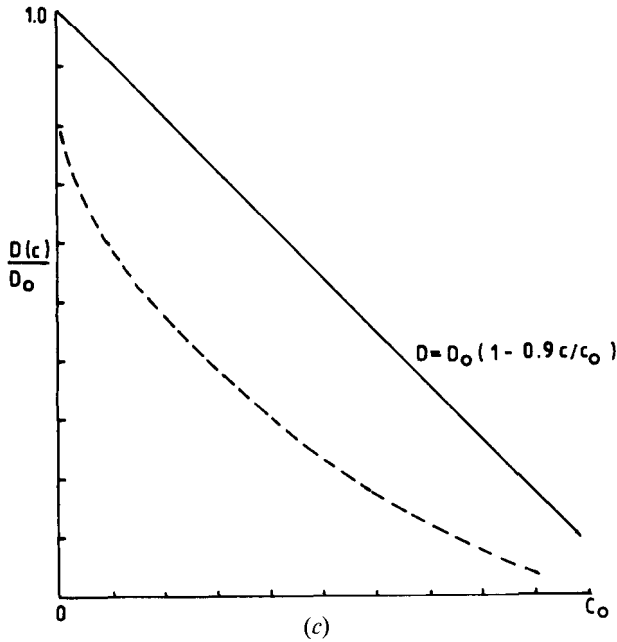

Figure 3.  $D(c)$  dependence computed from the concentration profiles  $c(x, t)$  with the approximation technique of Hakemi. Solid line: original dependence  $D = D_0(1 + D_1 c)$  upon which the computation of  $c(x, t)$  was based. Dashed line:  $D(c)$  computed from equation (4) at discrete concentrations. For non-zero  $D_1$ , the obvious deviations are caused by methodical inaccuracy which we avoid by fitting the data to the numerical solution of the diffusion equation.

show the original  $D(c)$  curves, the dashed lines represent the  $D$  values computed from  $c = c_0 \operatorname{erfc}(x/(4Dt)^{1/2})$ . The conclusion drawn from figure 3 is that, although some features of the dependence of  $D(c)$  are roughly similar, the approximation method gives generally diffusion coefficients which are too small. The explanation is as follows. The diffusion coefficient increases with lower concentrations, hence for equal concentration gradients the flow of the diffusant will be stronger as the distance from the source increases. Therefore the drain-to-source ratio in an arbitrary intermediate section of the diffusion channel will be greater than for constant  $D$ . The arising concentration is smaller. For low concentrations, far from the source, this effect is less dominant. Yet we have to take into account that the molecules found there have migrated, starting from the source, through the whole concentration profile. The resulting diffusion coefficient is a weighted average of all  $D(c)$  at higher concentrations. It is obvious from this discussion, and could be proved by calculations, that the discrepancies shown in figures 3(b, c) are not caused by the linear assumption in equation (6) (cf. figure 3(a)). Such artefacts arise because the use of equation (3) is unjustified in systems with continuously decreasing  $D(c)$ .

In the work of Hakemi, different initial and boundary conditions were present, but an exact mathematical computation of  $D(c)$  under these conditions should reveal in principle the same deviations. He posed a certain depletable amount of cholesteric, instead of the stock container, at the channel end. A gaussian shape of  $c(x, t)$  was assumed for the solution of the diffusion equation, which holds only for an initial delta distribution of  $c(x)$ . We could, in principle, calculate the actual total amount of the diffusant by integrating over  $c(x, t)$  (found from the distribution of Grandjean bands)



at an arbitrary time  $t > 0$ . Then, with the known initial concentration of the cholesteric, the true initial distribution could be found, and the corresponding diffusion equation could be solved. However, we find that the exact mathematical treatment under these conditions is difficult to perform and we prefer a constant source concentration.

**5. Conclusions**

With the proposed experiment, we have measured the diffusion of cholesteric ChUC into a nematic mixture. The results for several diffusion cells with different cell thickness and for all sampling times evaluated are in good agreement. Figure 4 shows the positions of the Grandjean bands scaled in units of  $x/t^{+0.5}$ , for the different cells 1..3. The best fit of the diffusion constant was found for

$$D = 10.6(1 - 0.196 \mu\text{m}/p_0) \mu\text{m}^2/\text{s},$$

which holds for concentrations of ChUC up to 6.7 per cent ( $p_0 > 2.8 \mu\text{m}$ ). This value is in good agreement with diffusion constants of other cholesteric liquid crystals.

If higher powers of  $c$  with additional coefficients are included in equation (6), the computed curves are very similar to those with the linear ansatz. At the present stage, the uncertainties of the experimental data are much too large to allow a determination of  $D(c)$  to a higher than linear degree with this optical method. Such attempts as well

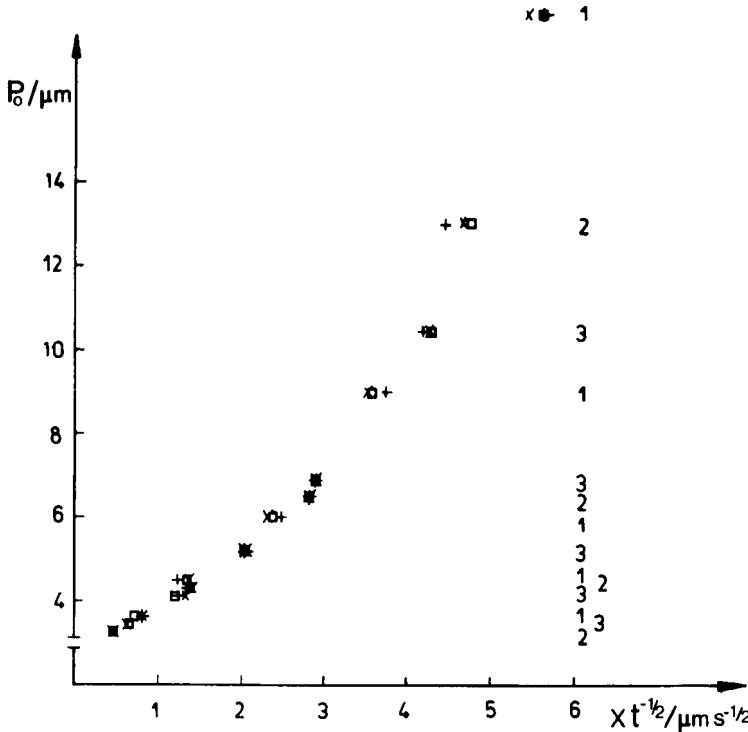

Figure 4. Location of the mid points between adjacent Grandjean bands in three different cells with thickness  $d$ : (1)  $d = 9.0 \mu\text{m}$ ; +,  $t = 0.436 \times 10^6 \text{ s}$ ; x,  $t = 1.632 \times 10^6 \text{ s}$ ;  $\square$ ,  $t = 3.410 \times 10^6 \text{ s}$ . (2)  $d = 6.5 \mu\text{m}$ ; +,  $t = 0.400 \times 10^6 \text{ s}$ ; x,  $t = 0.798 \times 10^6 \text{ s}$ ;  $\square$ ,  $t = 2.200 \times 10^6 \text{ s}$ . (3)  $d = 10.4 \mu\text{m}$ ; +,  $t = 0.440 \times 10^6 \text{ s}$ ; x,  $t = 1.801 \times 10^6 \text{ s}$ ;  $\square$ ,  $t = 2.651 \times 10^6 \text{ s}$ .

Downloaded At: 16:03 26 January 2011

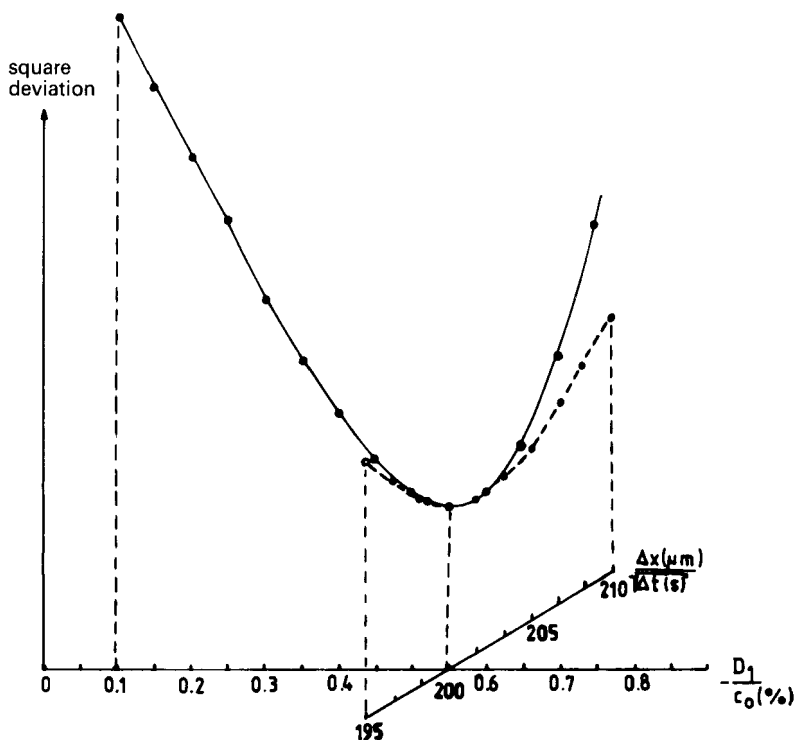

Figure 5. Sum of mean squared deviations of the fitted curves (in arbitrary units). Solid line: varying  $D_1$  with best adapted  $\Delta x$ . Dashed line: varying  $\Delta x$  at optimum  $D_1$ .

as the calculation of  $D(c)$  with the solutions of equation (3 a) may lead to artefacts. This holds also for the measurements published in [1–4].

A pitch dependence of diffusion perpendicular to the helix was also observed by other authors [4]. A molecule diffusing *along* the helix will have to change its orientation continuously, this may strongly influence the diffusion velocity. In contrast, the orientation of molecules in our experiment, diffusing perpendicular to the pitch is disturbed only in the vicinity of the disclination lines. We argue that such reorientation effects are not responsible for the pitch dependence of the diffusion coefficient. Rather, this dependence might be effected by the general steric and dispersive interactions of the chiral molecules with those of the nematic matrix. This assumption will have to be thoroughly examined by more detailed N.M.R. and mass transport investigations.

The authors wish to express their thanks to Professor H. Schmiedel, who stimulated the diffusion investigations, to the Halle Liquid Crystal Group of Professor D. Demus for providing the liquid crystals and to Dr. G. Hauck for his help in the surface preparation of the glass plates.

### References

- [1] HAKEMI, H., and LABES, M. M., 1974, *J. chem. Phys.*, **61**, 4020. HAKEMI, H., and LABES, M. M., 1974, *J. chem. Phys.*, **62**, 3708.
- [2] HAKEMI, H., 1983, *Physics Lett.*, **95**, A35.
- [3] HAKEMI, H., and VARANASI, P. P., 1985, *Liq. Crystals*, **1**, 63.

- [4] HAKEMI, H., 1983, *Molec. Crystals liq. Crystals*, **95**, 309; 1983, *J. chem. Phys.*, **79**, 309; 1982, *J. appl. Phys.*, **53**, 5333.
- [5] HEFFNER, W. R., BERREMAN, D. W., SAMMON, M., and MEIBOOM, S., 1980, *Appl. Phys. Lett.*, **36**, 144.
- [6] GOODMAN, L. A., MCGINN, J. T., ANDERSON, CH. H., and DIERONIMO, F., 1977, *I.E.E.E. Trans. Electron Devices*, **24**, 795.
- [7] NAEMURA, S., 1980, *J. appl. Phys.*, **51**, 6149.
- [8] ARMITAGE, D., 1980, *J. appl. Phys.*, **51**, 2552.
- [9] COGNARD, J., 1982, *Molec. Crystals liq. Crystals*, **Suppl. 1**, 1.
- [10] CRANK, J., 1956, *The Mathematics of Diffusion* (Oxford University Press).
- [11] YANIV, Z., CHIDICHIMO, G., VAZ, N. A. P., and DOANE, J. W., 1981, *Physics Lett.*, **A86**, 297.
- [12] LUZAR, M., LOZAR, B., and BLINC, R., 1984, *Molec. Crystals liq. Crystals.*, **113**, 291.